



Yealink Technical White Paper

**Virtual Local Area Network
(VLAN)**

Sep. 2017

About VLAN

VLAN (Virtual Local Area Network) is used to logically divide a physical network into several broadcast domains. VLAN membership can be configured through software instead of physically relocating devices or connections. Grouping devices with a common set of requirements regardless of their physical location can greatly simplify network design. VLANs can address issues such as scalability, security, and network management.

IEEE 802.1Q

IEEE 802.1Q is the networking standard that supports VLANs on an Ethernet network. The specification defines a standard method for tagging Ethernet packets with VLAN membership information. A VLAN-aware device is the one which understands VLAN memberships and VLAN formats. When a packet from the IP phone enters the VLAN-aware portion of the network, a tag is added to represent the VLAN membership of the IP phone. Each packet must be distinguishable as being within exactly one VLAN. A packet in the VLAN-aware portion of the network that does not contain a VLAN tag is assumed to be flowing on the native (or default) VLAN.

802.1Q adds a 4-byte tag between the source MAC address and the Ethernet type fields of the Ethernet frame. Two bytes are used for the tag protocol identifier (TPID), the other two bytes for tag control information (TCI). The TCI field is further divided into PCP (Priority Code Point), CFI (Canonical Format Indicator), and VID (VLAN ID).

Voice VLAN

As voice traffic is delay and jitter sensitive for the IP phone, it requires higher priority over data traffic to reduce delay and packet loss during transmission. To simplify configuration procedures and better manage voice transmission policies, the connected switch can be configured to provide voice VLAN function and transmit the voice traffic of the IP phone in a dedicated VLAN, called voice VLAN.

Voice VLAN is a special access port feature of the switch which allows IP phones to be automatically configured and easily associated with a logically separate VLAN. This feature provides various benefits, but one particular benefit is that when voice VLAN is enabled on a switch port, this port is also enabled to allow simultaneous access for a PC. This feature allows a PC to be daisy chained to an IP phone and the connection for both PC and IP phone to be trunked through the same physical Ethernet cable.

The purpose of VLAN configurations on the IP phone is to insert tag with VLAN information to the packets generated by the IP phone. When VLAN is properly configured for the ports (Internet port and PC port) on the IP phone, the IP phone will tag all packets from these ports with the VLAN ID. The switch receives and forwards the tagged packets to the corresponding VLAN according to the VLAN ID in the tags described in IEEE Std 802.3.

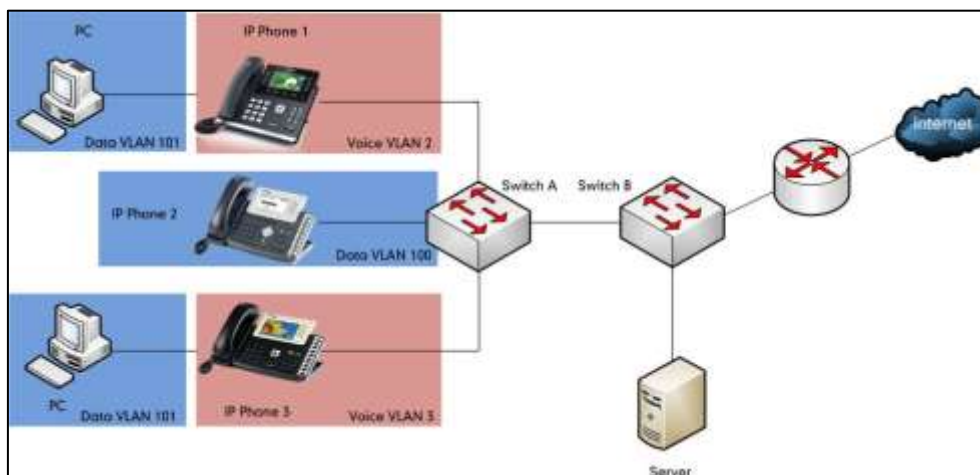

Major Benefits of Using VLANs

VLANs offer many benefits that are not found in typical LANs. Major benefits of segregating IP phones into VLAN(s) are listed as below:

- **Performance Enhancements:** VLAN is used to minimize the broadcast domain. Creating smaller domain for IP phone can reduce overhead and limit resource utilization. Additionally, less traffic will need to be routed, and the latency added by routers will be reduced.
- **Ease of Administration:** Much of the cost associated with network additions and relocations can be saved through the use of VLANs. IP phone can be shifted from one workgroup or department to another without installing new network cabling and reconfiguring hubs or routers.
- **Security:** VLANs can be used to create secure user groups and prevent others outside of the broadcast domain from receiving sensitive data of the IP phone. They can also be used to enhance firewall functions and restrict network access for one or more users. By segregating IP phones into VLANs, security filters can be implemented in the network to prevent the IP phones from receiving unnecessary traffic from other devices. This helps prevent disruption due to DoS attacks or attempts to compromise the devices. It also allows locking down access to configuration and signaling servers to only allow access from the IP phones.

Yalink IP Phones Compatible with VLAN Method

There are four ways to get VLAN ID for Internet (WAN) port, but the VLAN used is chosen by the priority of each method (from highest to lowest): LLDP/CDP>Manual>DHCP VLAN. There is only one way to get VLAN ID for PC port: Manual.

Yalink SIP VP-T49G IP phones support VLAN in the wireless network. The method that the phones use to obtain VLAN ID in the wireless network is the same as the one in the wired network.

Note

LLDP and CDP methods have the same priority to get VLAN ID. Normally, the VLAN ID get for the IP phone by LLDP and CDP methods will be the same.

The table below lists the methods supported by Yalink SIP IP phones with different versions.

Method	IP Phone Models	Firmware Version
LLDP	All IP phones	All Versions
Manual	All IP phones Note: The Manual method for PC port is not available on Yalink CP860, CP920 W60, W52P and W56P IP phones.	All Versions
DHCP VLAN	W52P	Firmware version 40 or later.
	T46G, T42G, T41P and CP860	Firmware version 71 or later
	T48G	Firmware version 72 or later.
	T58V/A, T56A, T49G, T40P, T29G, T27P, T23P/G, T21(P) E2, T19(P) E2, CP960 and W56P	Firmware version 80 or later
	T54S, T52S, T48S, T46S, T42S, T41S, T40G, T27G and CP920	Firmware version 81 or later
CDP	T58V/A, T56A, T49G, T48G, T46G, T42G, T41P, T40P, T29G, T27P, T23P/G, T21(P) E2, T19(P)	Firmware version 80 or later

Method	IP Phone Models	Firmware Version
	E2, CP860 and CP960	
	T54S, T52S, T48S, T46S, T42S, T41S, T27G and CP920	Firmware version 81 or later

VLAN Discovery Method on Yealink IP Phones

Automatic Discovery Method for VLAN

LLDP

Introduction

LLDP (Link Layer Discovery Protocol) allows IP phones to receive and/or transmit device-related information to directly connected devices on the network that are also using the protocol, and store the information that is learned about other devices. Information gathered with LLDP is stored in the device as a management information database (MIB) and can be queried with the Simple Network Management Protocol (SNMP) as specified in RFC 2922. LLDP transmits information as packets called LLDP Data Units (LLDPDUs). An LLDPDU consists of a set of Type-Length-Value (TLV) elements, each of which contains a particular type of information about the device or port transmitting it.

Each of the TLV components has the following basic structure:

Type	Length	Value
7 bits	9 bits	0-511 octets

LLDP supports advertising the following TLVs:

- **Mandatory LLDP TLVs:** Chassis ID, Port ID, and Time to Live (TTL) are included in an LLDPDU by default.
- **Optional LLDP TLVs:** System Name, System Description and so on, the phone sends the optional TLVs along with the mandatory TLVs in an LLDPDU.
- **Organizationally Specific TLVs:** MAC/PHY Configuration/Status and Port VLAN ID, which are defined in IEEE Standard 802.3 and 802.1 respectively.

The LLDP frame ends with a special TLV, named **end of LLDPDU** in which both the **type** and **length** fields are 0.

LLDP-MED

LLDP-MED (Media Endpoint Discovery) is published by the Telecommunications Industry Association (TIA). It is an extension to LLDP that operates between endpoint devices and network connectivity devices. LLDP-MED specifically provides support for voice over IP (VoIP) applications and provides the following capabilities:

- Capabilities Discovery—allows LLDP-MED endpoints to determine the capabilities that the connected device supports and has enabled. It can be used to indicate whether the connected device is a phone, a switch, a repeater, etc.
- Voice VLAN Configuration—provides a mechanism for a switch to notify a device which VLAN to use, which enables “plug and play” networking.
- Power Management—provides information related to how the device is powered, power priority, and how much power the device needs.
- Inventory Management—provides a means to manage device and the attributes of the device such as model number, serial number, software revision, etc.
- Location Identification Discovery—provides location information from the switch to the device when placing an emergency call.

In addition to the TLVs advertised by LLDP, LLDP-MED also supports advertising the following TLVs:

- LLDP-MED capabilities TLV
- Network policy TLV
- Power management TLV
- Inventory management TLV
- Location identification TLV (not supported by IP phones)

It should be noted that either LLDP or LLDP-MED—but not both—can be used at any given time on an interface between two devices.

LLDP Feature on Yealink IP Phones

LLDP provides exceptional interoperability benefits, IP telephony troubleshooting, automatic deployment of policies and advanced PoE (Power over Ethernet). When LLDP feature is enabled on IP phones, the IP phones periodically advertise their own information to the directly connected LLDP-enabled switch. The IP phones can also receive LLDP packets from the connected switch. When the application type is “voice”, IP phones decide whether to update the VLAN configurations obtained from the LLDP packets. When the VLAN configurations on the IP phones are different from the ones sent by the switch, the IP phones perform an update and reboot. This allows the IP phones to be plugged into any switch, obtain their VLAN IDs, and then start communications with the call control.

Supported TLVs of IP Phones

TLVs supported by IP phones are summarized in the following table:

TLV Type	TLV Name	Description
Mandatory TLVs	Chassis ID	Specifies the IP address of the IP phone.
	Port ID	Specifies the MAC address of the IP phone.
	Time to Live	Specifies the lifetime of the transmitted information on the IP phone. The default value is 180s.
	End of LLDPDU	Marks the end of the TLV sequence in the LLDPDU. No further processing of TLVs after this is necessary. This is a mandatory TLV and therefore must be present at the end of the data stream.
Optional TLVs	System Name	Specifies the administratively-assigned name for the IP phone (per RFC3418). For more information, refer to Appendix B: System Names on page 35.
	System Description	Specifies the description of the IP phone.
	System Capabilities	Specifies the supported and enabled capabilities of the IP phone. For Yealink CP860, CP960, CP920 W52P, W56P, W60, SIP-T58V/T58A/T56A, SIP VP-T49G, SIP-T54S/T52S/T48G/T48S/T46G/T46S/T42G/T42S/T41P/T41S /T40P/T40G/T29G/T27P/T27G/T23P/T23G/T21(P) E2/T19(P) E2: The supported capabilities are Telephone. The enabled capabilities are Telephone by default.
	Port Description	Specifies the description of the sending port. The default value is "WAN PORT".
IEEE Std 802.3 Organizationally Specific TLV	MAC/PHY Configuration/Status	Specifies duplex and bit rate settings of the IP phone. The Auto-Negotiation is supported and enabled by default. The advertised capabilities of PMD Auto-Negotiation are: <ul style="list-style-type: none"> • 10BASE-T (half duplex mode) • 10BASE-T (full duplex mode) • 100BASE-TX (half duplex mode) • 100BASE-TX (full duplex mode) • 1000BASE-T (full duplex mode).

TLV Type	TLV Name	Description
		<p>Note: By default, all phones have the PMD Advertised Capability set for 10BASE-T and 100BASE-TX. Yealink CP860/CP920/SIP-T58V/T58A/T56A/SIP VP-T49G/SIP-T54S/T52S/T48G/T48S/T46G/T46S/T42G/T42S/T29G/T27G/T23G phones that have Gigabit Ethernet support PMD Advertise Capability also contain set 100BASE-T.</p>
LLDP-MED TLVs	Media Capabilities	<p>Specifies the MED device type of the IP phone and the supported LLDP-MED TLV type can be encapsulated in LLDPDU.</p> <p>The supported LLDP-MED TLV types are:</p> <ul style="list-style-type: none"> • LLDP-MED Capabilities • Network Policy • Extended Power via MDI-PD • Inventory
	Network Policy	Specifies the port VLAN ID, application type, L2 priority and DSCP value.
	Extended Power-via-MDI	<p>Specifies power type, source, priority and value.</p> <p>For more information on power value, refer to Appendix C: Model Names on page 36.</p>
	Inventory - Hardware Revision	Specifies the hardware revision of IP phone.
	Inventory - Firmware Revision	Specifies the firmware revision of IP phone.
	Inventory - Software Revision	Specifies the software revision of IP phone.
	Inventory - Serial Number	Specifies the serial number of IP phone.
	Inventory - Manufacturer Name	<p>Manufacturer name of IP phone.</p> <p>The default value is "Yealink".</p>
LLDP-MED TLVs	Inventory - Model Name	<p>Specifies the model name of IP phone.</p> <p>For more information, refer to Appendix C: Model Names on page 36</p>

TLV Type	TLV Name	Description
	Asset ID	Specifies the asset identifier of IP phone.

Configuring LLDP Feature on Yealink IP Phones

LLDP is enabled on IP phones by default. You can configure LLDP via web user interface or using configuration files. You can also configure the sending frequency of LLDP packet. The default sending frequency is 60s.

Configuring LLDP via Web User Interface

The followings take configurations of a SIP-T46G IP phone running firmware version 81 as examples.

To configure LLDP feature via web user interface:

1. Log into the web user interface with the administrator credential.
The default administrator user name and password are both "admin".
2. Click on **Network->Advanced**.
3. In the **LLDP** block, select the desired value from the pull-down list of **Active**.
4. Enter the desired time (in seconds) in the **Packet Interval (1~3600s)** field.



5. Click **Confirm** to accept the change.
The web user interface prompts the warning "Some settings you changed take effect when you restart your machine! Do you want to reboot now?".
6. Click **OK** to reboot the IP phone.

Configuring LLDP Using Configuration Files

The following IP phones use the new auto provisioning mechanism:

- SIP-T58V/T58A/T56A/CP960 IP phones running firmware version 80 or later

- SIP-T54S/T52S/T48G/T48S/T46G/T46S/T42G/T42S/T41P/T41S/T40P/T40G/T29G/T27P/T27G/T23P/T23G/T21(P) E2/T19(P) E2, CP860, CP920, W60, W52P and W56P IP phones running firmware version 81 or later

Other IP phones or the IP phones listed above running old firmware version use the old auto provisioning mechanism.

For Old Auto Provisioning Mechanism

To configure LLDP feature using configuration files:

1. Add/Edit LLDP parameters in the configuration file (e.g., y000000000028.cfg).

The following table shows the information of parameters:

Parameters	Permitted Values	Default
network.lldp.enable	0 or 1	1
Description: Enables or disables LLDP on the IP phone. 0 -Disabled 1 -Enabled		
network.lldp.packet_interval	Integer from 1 to 3600	60
Description: Configures the interval (in seconds) for the IP phone to send the LLDP request.		

The following shows an example of LLDP configuration in configuration files:

```
network.lldp.enable = 1
network.lldp.packet_interval = 60
```

2. Upload configuration files to the root directory of the provisioning server and trigger IP phones to perform an auto provisioning for configuration update.

For more information on auto provisioning, refer to [Yealink SIP-T2 Series_T19\(P\) E2_T4 Series_CP860_W56P_IP_Phones_Auto_Provisioning_Guide](#).

For New Auto Provisioning Mechanism

To configure LLDP feature using configuration files:

1. Add/Edit LLDP parameters in the configuration file (e.g., static.cfg).

The following table shows the information of parameters:

Parameters	Permitted Values	Default
static.network.lldp.enable	0 or 1	1

Parameters	Permitted Values	Default
Description: Enables or disables LLDP on the IP phone. 0 -Disabled 1 -Enabled		
static.network.lldp.packet_interval	Integer from 1 to 3600	60
Description: Configures the interval (in seconds) for the IP phone to send the LLDP request.		

The following shows an example of LLDP configuration in configuration files:

```
static.network.lldp.enable = 1
static.network.lldp.packet_interval = 60
```

- Reference the configuration file in the boot file (e.g., y000000000000.boot).

Example:

```
include:config "http://10.2.1.158/static.cfg"
```

- Upload the boot file and configuration file to the root directory of the provisioning server.
- Trigger IP phones to perform an auto provisioning for configuration update.

For more information on auto provisioning, refer to [Yealink SIP IP Phones Auto Provisioning Guide_V81](#).

Verifying the Configuration

After LLDP feature is enabled, the IP phone performs the following:

- Periodically advertises information (e.g., hardware revision, firmware revision, serial number) of the IP phone to a multicast address on the network.
- Allows LLDP packets to be received from the Internet (WAN) port or WLAN port.
- Supports the MAC/PHY configuration (e.g., speed rate, duplex mode).
- Obtains VLAN info from the network policy, which takes precedence over manual settings.

The following figure shows the LLDP packet sent by the IP phone, the packet contains multiple TLVs (before obtaining VLAN ID).

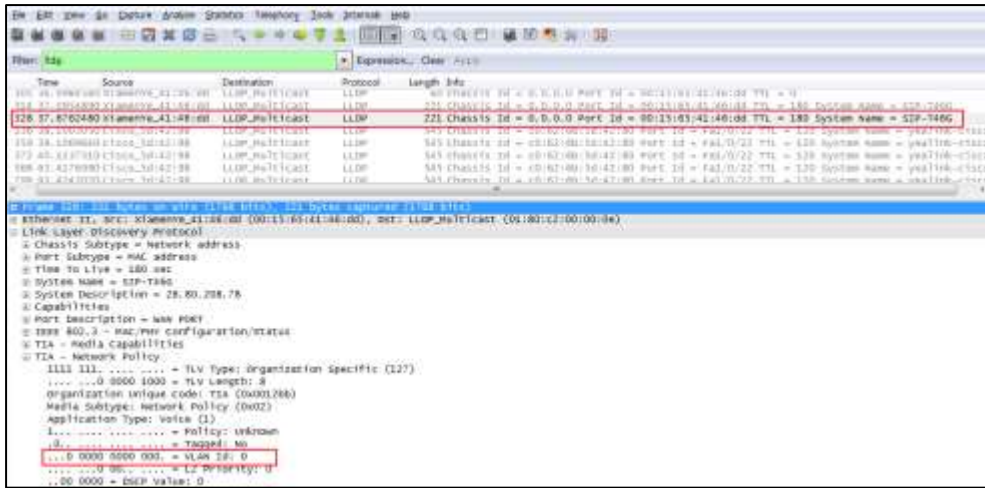

The following figure shows the LLDP packet received by the IP phone, the packet contains multiple TLVs (sent by the switch).

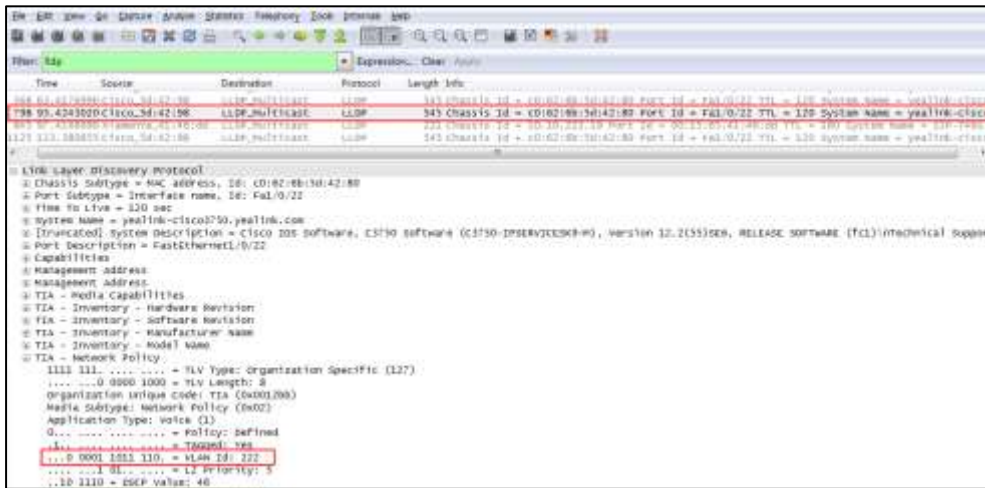

The following figure shows the LLDP packet sent by the IP phone, the packet contains multiple TLVs (after obtaining VLAN ID).

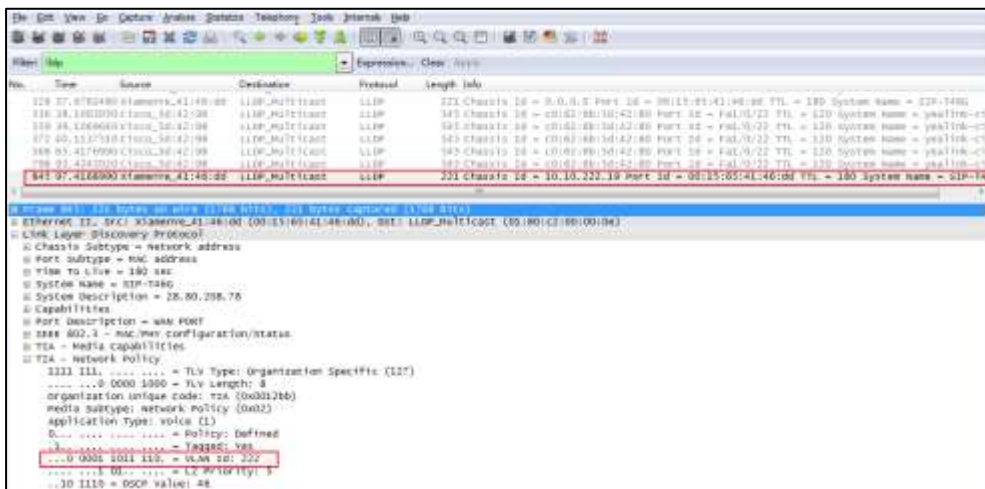

CDP

Introduction

CDP (Cisco Discovery Protocol) allows IP phones to receive and/or transmit device-related information from/to directly connected devices on the network that are also using the protocol, and store the information about other devices.

CDP Feature on Yealink IP Phones

When CDP feature is enabled on IP phones, the IP phones periodically advertise their own information to the directly connected CDP-enabled switch. The IP phones can also receive CDP packets from the connected switch. When the VLAN configurations on the IP phones are different from the ones sent by the switch, the IP phones perform an update and reboot. This allows the IP phones to be plugged into any switch, obtain their VLAN IDs, and then start communications with the call control.

Configuring CDP Feature on Yealink IP Phones

CDP is disabled on IP phones by default. You can configure CDP via web user interface or using configuration files. You can also configure the sending frequency of CDP packet. The default sending frequency is 60s.

Configuring CDP via Web User Interface

The followings take configurations of a SIP-T46G IP phone running firmware version 81 as examples.

To configure CDP feature via web user interface:

1. Log into the web user interface with the administrator credential.
The default administrator user name and password are both "admin".
2. Click on **Network->Advanced**.
3. In the **CDP** block, select the desired value from the pull-down list of **Active**.

4. Enter the desired time (in seconds) in the **Packet Interval (1~3600s)** field.



5. Click **Confirm** to accept the change.

The web user interface prompts the warning “Some settings you changed take effect when you restart your machine! Do you want to reboot now?”.

6. Click **OK** to reboot the IP phone.

Configuring CDP Using Configuration Files

The following IP phones use the new auto provisioning mechanism:

- SIP-T58V/T58A/T56A/CP960 IP phones running firmware version 80 or later
- SIP-T54S/T52S/T48G/T48S/T46G/T46S/T42G/T42S/T41P/T41S/T40P/T40G/T29G/T27P/T27G/T23P/T23G/T21(P) E2/T19(P) E2, CP860, CP920, W60, W52P and W56P IP phones running firmware version 81 or later

Other IP phones or the IP phones listed above running old firmware version use the old auto provisioning mechanism.

For Old Auto Provisioning Mechanism

To configure CDP feature using configuration files:

1. Add/Edit CDP parameters in the configuration file (e.g., y00000000028.cfg).

The following table shows the information of parameters:

Parameters	Permitted Values	Default
network.cdp.enable	0 or 1	0
<p>Description: Enables or disables CDP on the IP phone. 0-Disabled</p>		

Parameters	Permitted Values	Default
1-Enabled		
network.cdp.packet_interval	Integer from 1 to 3600	60
Description: Configures the interval (in seconds) for the IP phone to send the CDP request.		

The following shows an example of CDP configuration in configuration files:

```
network.cdp.enable = 1
network.cdp.packet_interval = 60
```

2. Upload configuration files to the root directory of the provisioning server and trigger IP phones to perform an auto provisioning for configuration update.

For more information on auto provisioning, refer to [Yealink SIP-T2 Series_T19\(P\) E2_T4_Series_CP860_W56P_IP_Phones_Auto_Provisioning_Guide](#).

For New Auto Provisioning Mechanism

To configure CDP feature using configuration files:

1. Add/Edit CDP parameters in the configuration file (e.g., static.cfg).

The following table shows the information of parameters:

Parameters	Permitted Values	Default
static.network.cdp.enable	0 or 1	0
Description: Enables or disables CDP on the IP phone. 0-Disabled 1-Enabled		
static.network.cdp.packet_interval	Integer from 1 to 3600	60
Description: Configures the interval (in seconds) for the IP phone to send the CDP request.		

The following shows an example of CDP configuration in configuration files:

```
static.network.cdp.enable = 1
static.network.cdp.packet_interval = 60
```

2. Reference the configuration file in the boot file (e.g., y000000000000.boot).

Example:

```
include:config "http://10.2.1.158/static.cfg"
```

3. Upload the boot file and configuration file to the root directory of the provisioning server.

4. Trigger IP phones to perform an auto provisioning for configuration update.

For more information on auto provisioning, refer to [Yealink SIP IP Phones Auto Provisioning Guide_V8.1](#).

Verifying the Configuration

After CDP feature is enabled, the IP phone performs the following:

- Periodically advertises information (e.g., software revision, device ID, power consumption) of the IP phone to a multicast address on the network.
- Allows CDP packets to be received from the Internet (WAN) port or WLAN port.
- Obtains VLAN ID of connecting ports.

The following figure shows the CDP packet sent by the IP phone (before obtaining VLAN ID-with VLAN Query field).

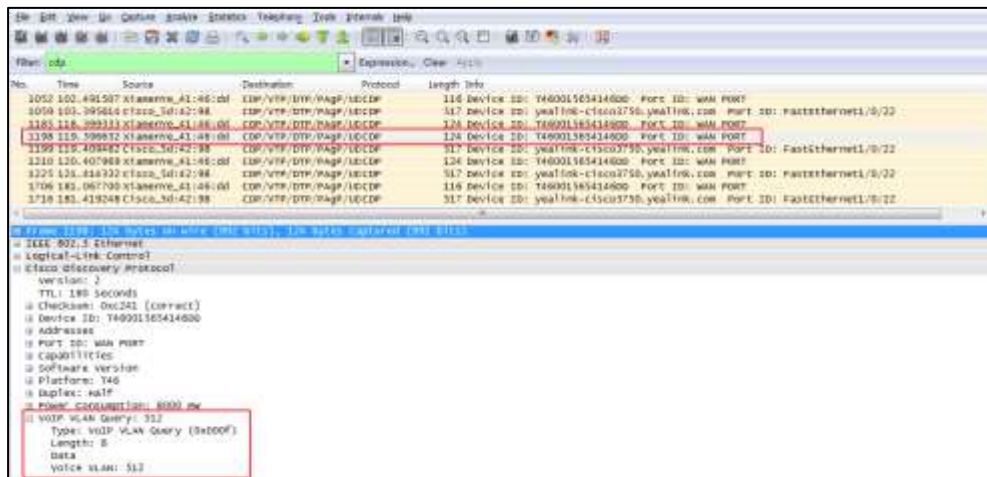

The following figure shows the CDP packet received by the IP phone (with VLAN Reply field).

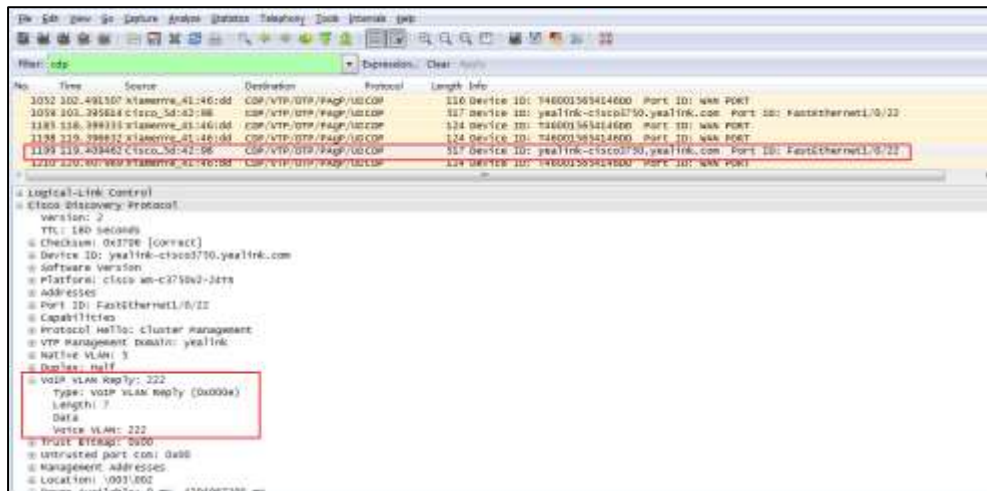

The following figure shows the CDP packet sent by the IP phone (after obtaining VLAN ID-without VLAN Query field).

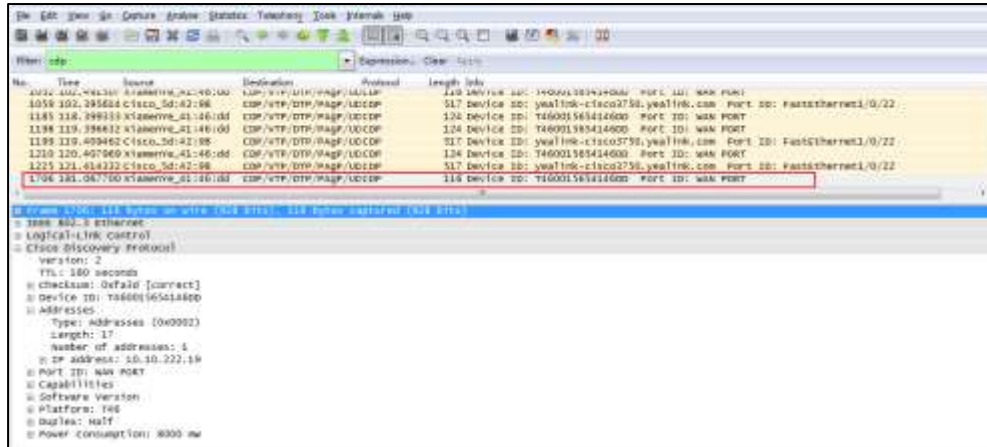

DHCP VLAN

IP phones support VLAN discovery via DHCP. When the VLAN Discovery method is set to DHCP, the IP phone will detect DHCP option for a valid VLAN ID. The predefined option 132 is used to supply the VLAN ID by default. You can customize the DHCP option used to detect the VLAN ID.

Configuring DHCP Option on a DHCP Server

Before using DHCP VLAN feature on IP phones, you must make sure that the DHCP option on the DHCP server is configured properly. This section provides instructions on how to configure a DHCP option for windows using DHCP Turbo.

To configure DHCP option on a DHCP server:

1. Start the DHCP Turbo application.
2. Right click **Option Types**, and then select **New Option Type**.

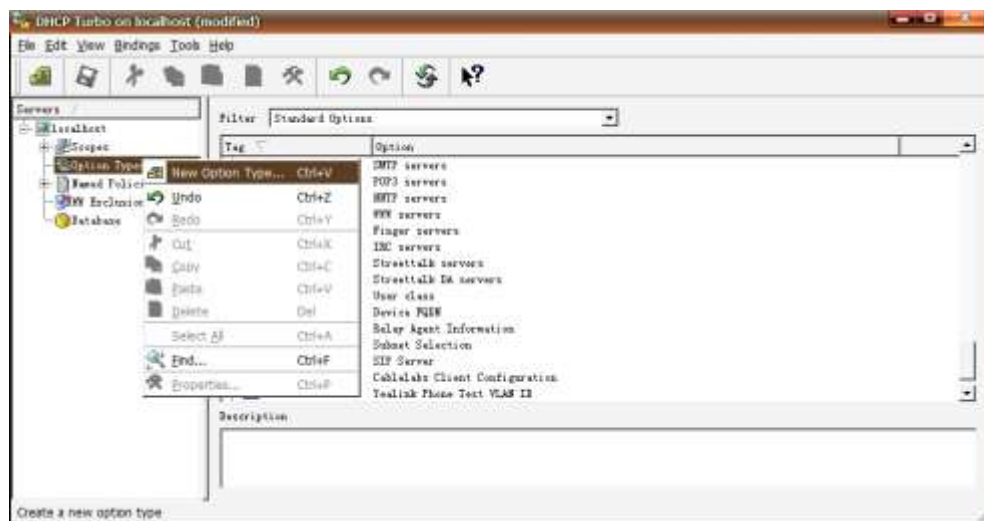

3. Enter the desired option in the **Tag** field.
The custom options range from 128 to 254.
4. Enter the desired name in the **Name** field.
5. Select **string** from the pull-down list of **Type**.

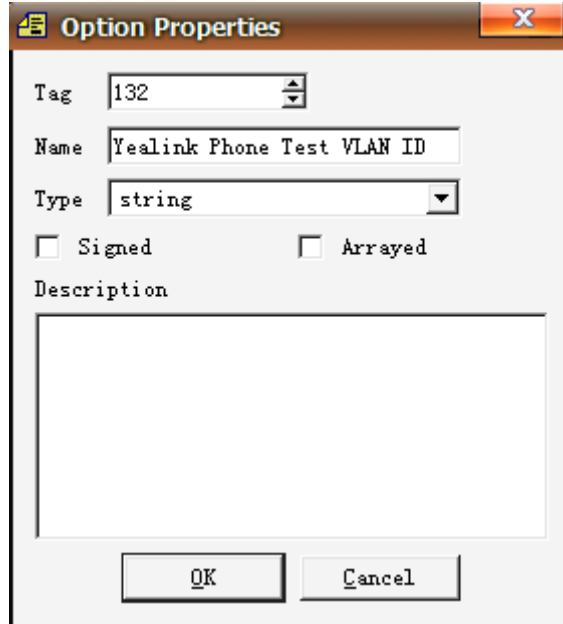

6. Click **OK** to finish setting the option properties.
7. Click  to accept the change.
8. Double click **Named Policies**.
9. Right click **Global**, and then select **New Option**.

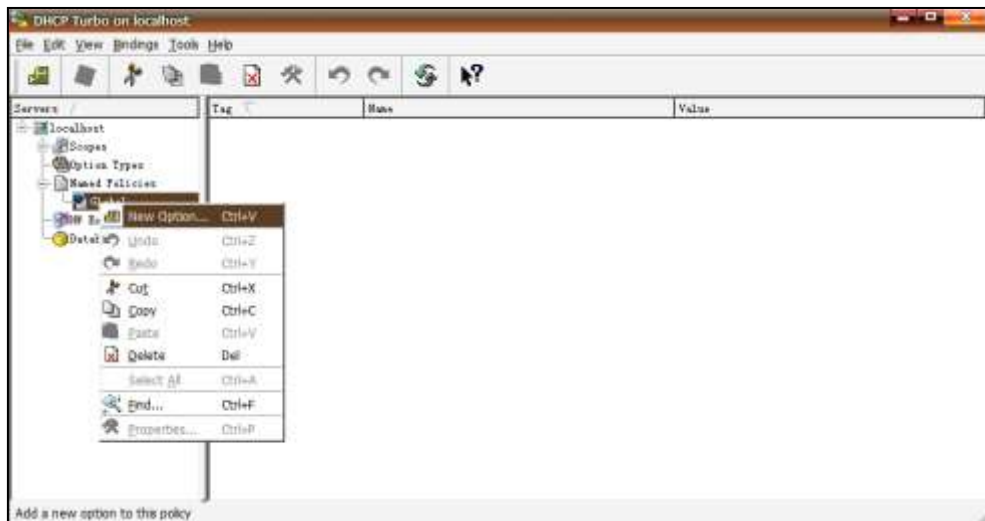

The Option Selector screen displays as below:

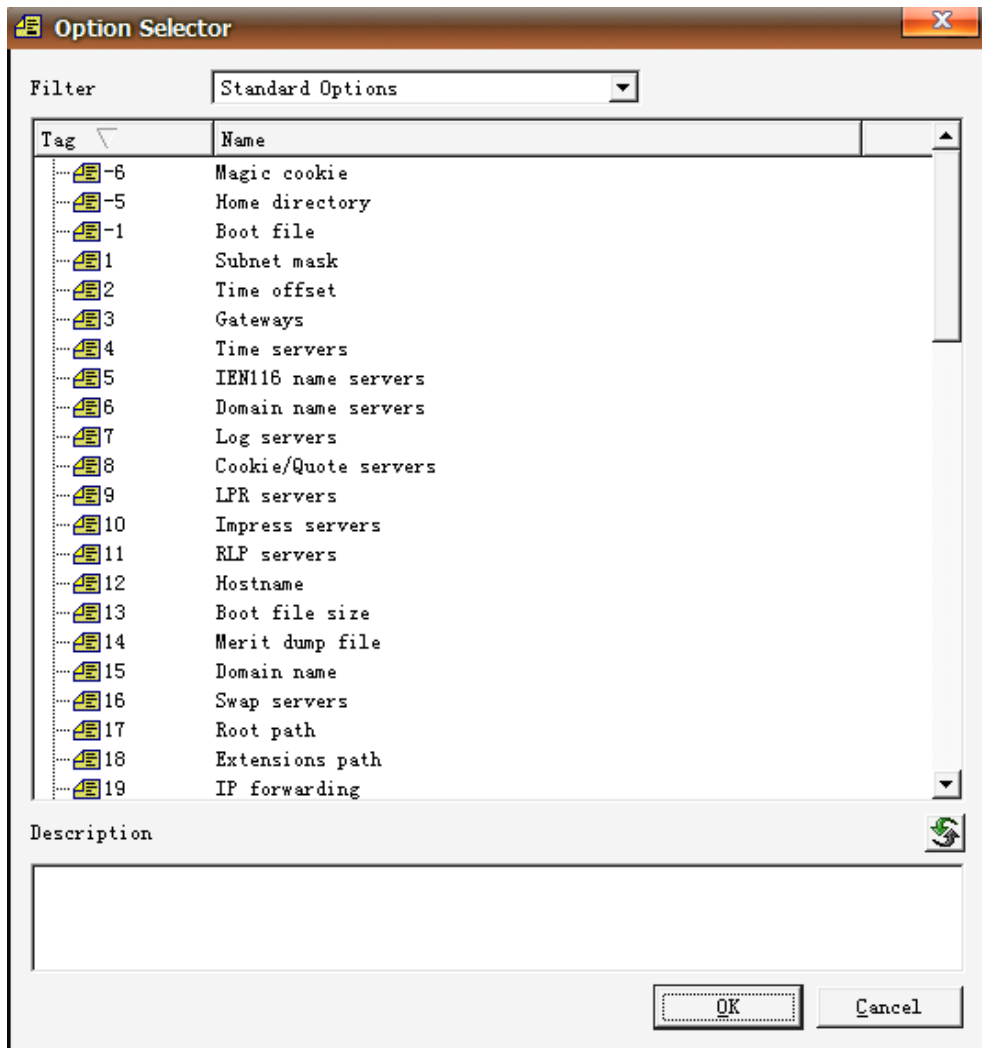

10. Scroll down and double click the option created above.

11. Fill the VLAN ID to be assigned in the input field.

Three formats of valid values: VLAN-A= *VLANID*, *VLANID* and VID= *VLANID*. VLAN ID ranges from 1 to 4094.

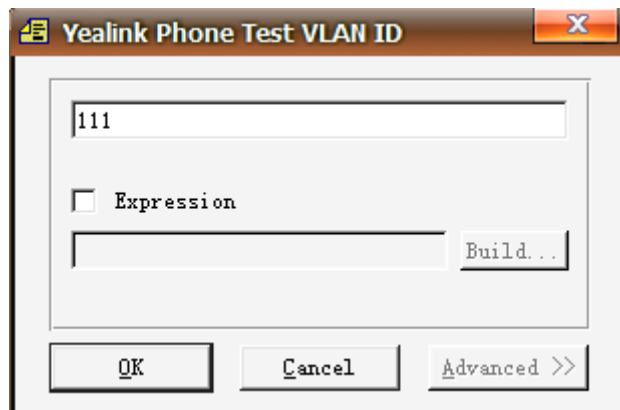

12. Click **OK** to finish setting a custom option.

13. Click  to accept the change.

Then you can find the configured option under **Global** option.

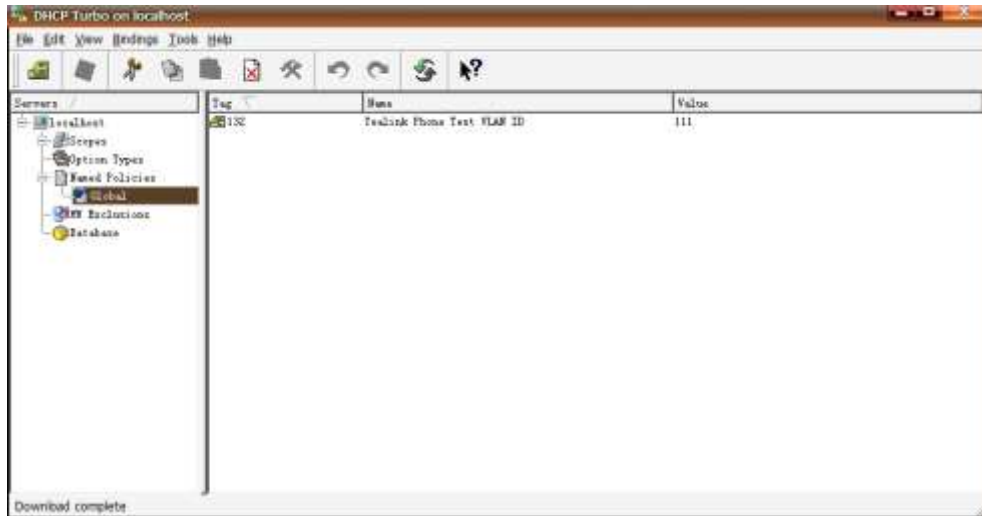

Configuring DHCP Option on Yealink IP Phones

DHCP VLAN is enabled on IP phones by default. You can configure DHCP VLAN via web user interface or using configuration files. You can also configure the DHCP option. The default DHCP option is 132.

Configuring DHCP Option via Web User Interface

The followings take configurations of a SIP-T46G IP phone running firmware version 81 as examples.

To configure DHCP VLAN feature via web user interface:

1. Log into the web user interface with the administrator credential.
The default administrator user name and password are both "admin".
2. Click on **Network->Advanced**.
3. In the **VLAN** block, select the desired value from the pull-down list of **DHCP VLAN Active**.
4. Enter the desired value in the **Option** field.

You can specify 5 options at most and separate options by commas. The default value is 132.



5. Click **Confirm** to accept the change.
The web user interface prompts the warning “Some settings you changed take effect when you restart your machine! Do you want to reboot now?”.
6. Click **OK** to reboot the IP phone.

Configuring CDP Using Configuration Files

The following IP phones use the new auto provisioning mechanism:

- SIP-T58V/T58A/T56A/CP960 IP phones running firmware version 80 or later
- SIP-T54S/T52S/T48G/T48S/T46G/T46S/T42G/T42S/T41P/T41S/T40P/T40G/T29G/T27P/T27G/T23P/T23G/T21(P) E2/T19(P) E2, CP920, W60, W52P and W56P IP phones running firmware version 81 or later

Other IP phones or the IP phones listed above running old firmware version use the old auto provisioning mechanism.

For Old Auto Provisioning Mechanism

To configure DHCP VLAN feature using configuration files:

1. Add/Edit DHCP VLAN parameters in the configuration file (e.g., y000000000028.cfg).

The following table shows the information of parameters:

Parameters	Permitted Values	Default
network.vlan.dhcp_enable	0 or 1	1
Description: Enables or disables DHCP VLAN discovery feature on the IP phone.		

Parameters	Permitted Values	Default
0 -Disabled 1 -Enabled		
network.vlan.dhcp_option	Integer from 128 to 254	132
Description: Specifies the DHCP option used to detect the VLAN ID. You can specify 5 options at most and separate options by commas.		

The following shows an example of DHCP VLAN configuration in configuration files:

```
network.vlan.dhcp_enable = 1
network.vlan.dhcp_option = 132
```

- Upload configuration files to the root directory of the provisioning server and trigger IP phones to perform an auto provisioning for configuration update.

For more information on auto provisioning, refer to [Yealink SIP-T2 Series T19\(P\) E2_T4_Series_CP860_W56P_IP_Phones_Auto_Provisioning_Guide](#).

For New Auto Provisioning Mechanism

To configure DHCP VLAN feature using configuration files:

- Add/Edit DHCP VLAN parameters in the configuration file (e.g., static.cfg).

The following table shows the information of parameters:

Parameters	Permitted Values	Default
static.network.vlan.dhcp_enable	0 or 1	1
Description: Enables or disables DHCP VLAN discovery feature on the IP phone. 0 -Disabled 1 -Enabled		
static.network.vlan.dhcp_option	Integer from 128 to 254	132
Description: Specifies the DHCP option used to detect the VLAN ID. You can specify 5 options at most and separate options by commas.		

The following shows an example of DHCP VLAN configuration in configuration files:

```
static.network.vlan.dhcp_enable = 1
```

```
static.network.vlan.dhcp_option = 132
```

5. Reference the configuration file in the boot file (e.g., y000000000000.boot).

Example:

```
include:config "http://10.2.1.158/static.cfg"
```

6. Upload the boot file and configuration file to the root directory of the provisioning server.
7. Trigger IP phones to perform an auto provisioning for configuration update.

For more information on auto provisioning, refer to [Yealink SIP IP Phones Auto Provisioning Guide_V81](#).

Verifying the Configuration

When the IP phone is configured to use DHCP for VLAN discovery, and the DHCP option is set to 132, the following processes occur:

1. The IP phone broadcasts a DHCP Discover message to find out if there is a DHCP server available.
2. If the DHCP server sends a DHCP Offer message with the Option 132, the phone will accept the Offer, send a DHCP Request, and save the VLAN ID provided by the DHCP server in the DHCP option 132.
3. After obtaining the VLAN ID from DHCP server, the phone will release the leased IP address and start a new DHCP Discover cycle with the now known Voice VLAN ID tag.

After this process, the phone will send all packets with the VLAN ID obtained from the DHCP server in the DHCP option 132.

The following figure shows the DHCP Discover message sent by the IP phone (before obtaining VLAN ID):

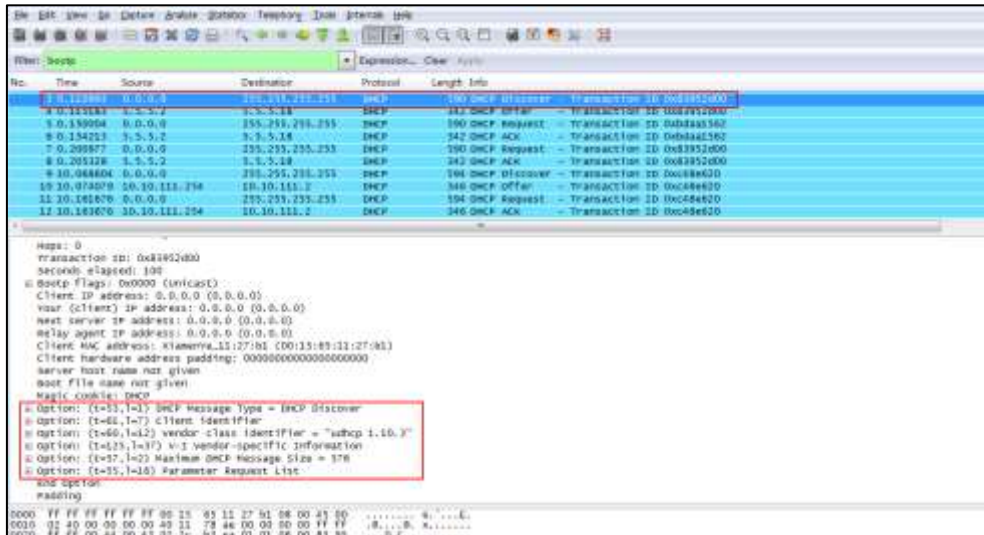
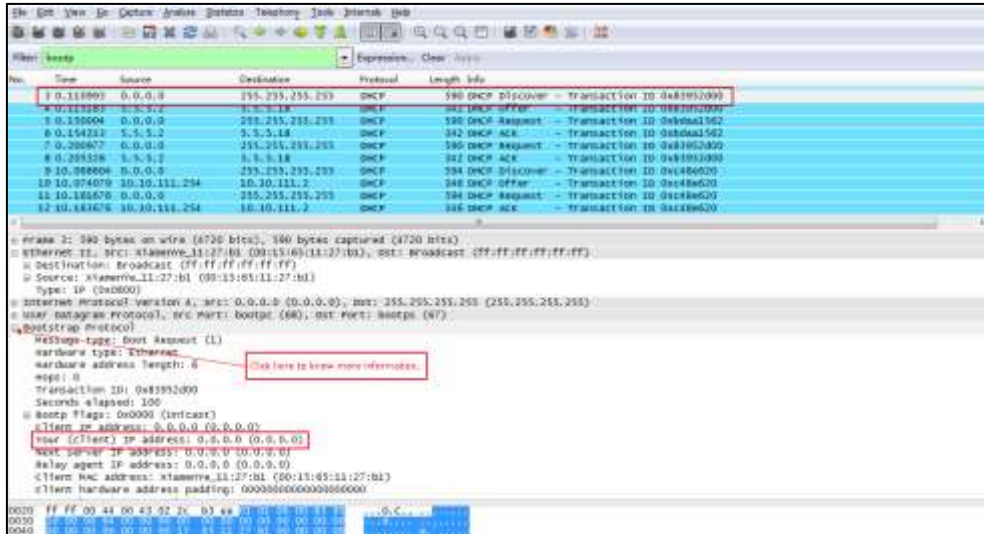

The following figure shows the DHCP Offer message received by the IP phone (DHCP server sends a DHCP Offer message with the Option 132):

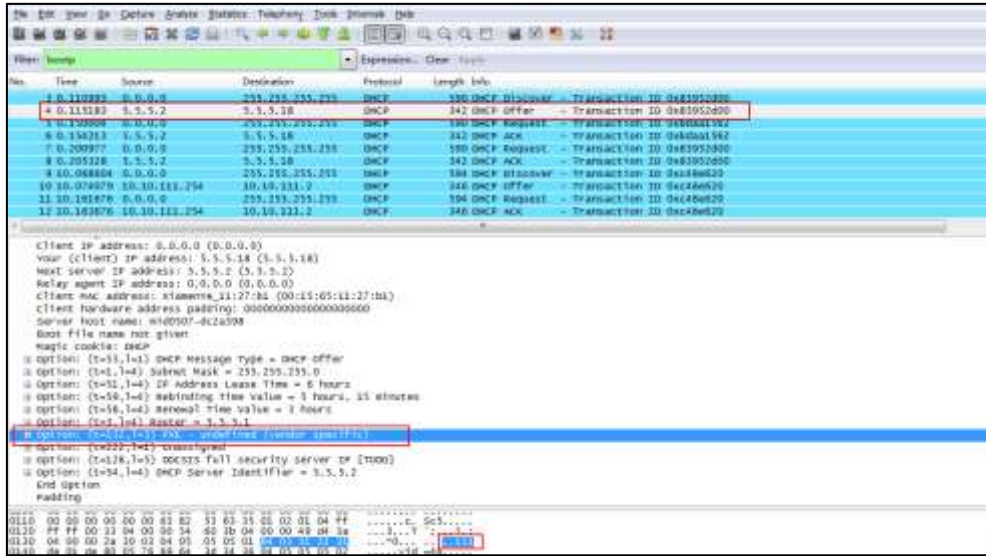

The following figure shows the DHCP message received by the IP phone (DHCP server sent the ACK message to the phone):

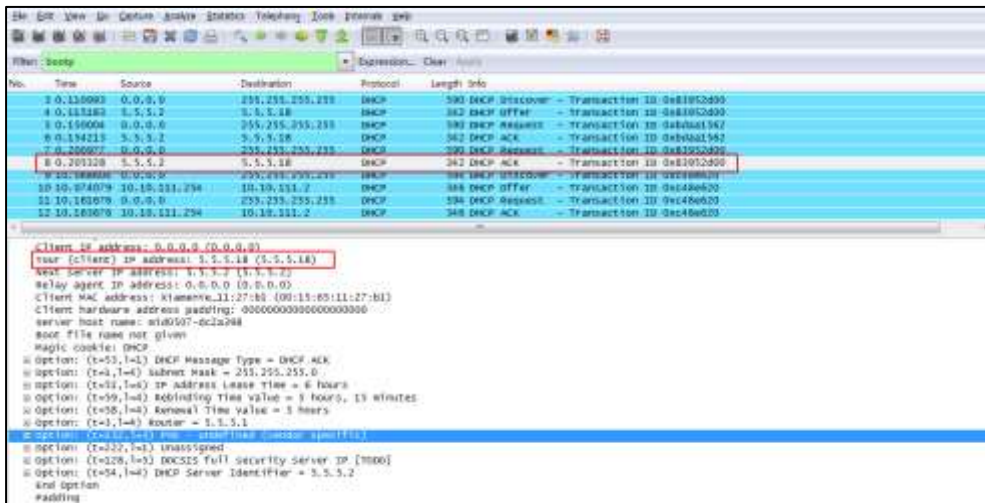

After obtaining the VLAN ID from DHCP server, IP phone will release the leased IP address (5.5.5.18) and start a new DHCP Discover message with the VLAN-tag 111.

The following figure shows the DHCP messages received by the IP phone:

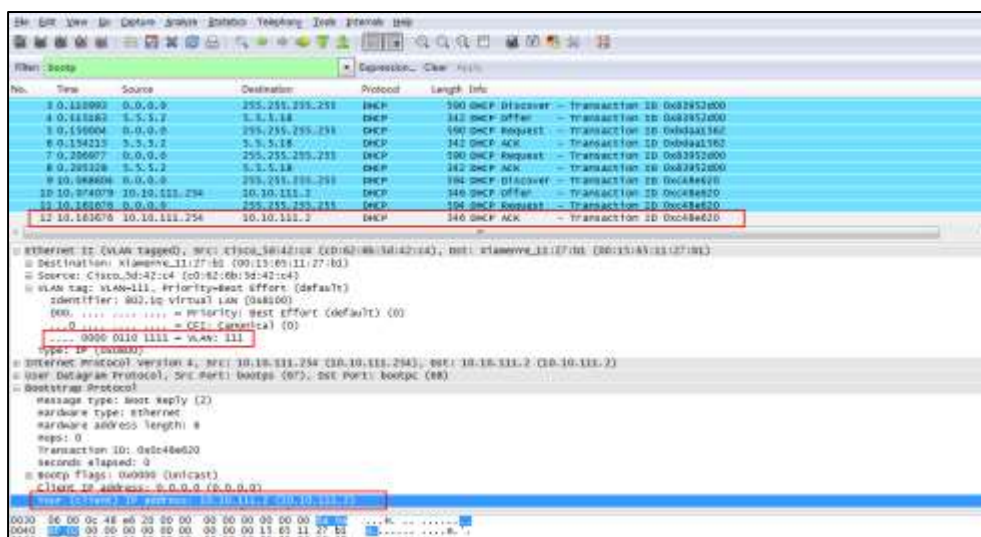

After this process, the phone has obtained an IP address (10.10.111.2) from the DHCP server in the VLAN 111.

Manual Configuration for VLAN

VLAN is disabled on IP phones by default. You can configure VLAN via web user interface or phone user interface or using configuration files. Before configuring VLAN on the IP phone, you need to obtain the VLAN ID from your network administrator. When you configure VLAN feature, the most important issue is to confirm the type of the connected port (access, trunk, and hybrid) on the switch. This ensures that the traffics (tagged/untagged) from the IP phones can be transmitted properly. VLAN feature could affect the ability of the IP phones to function in the network. Contact your network administrator for more information before configuration.

Configuring VLAN Feature in the Wired Network

You can enable or disable VLAN, and set specific VLAN IDs and priorities for the Internet (WAN) port and PC port respectively.

Configuring VLAN Feature in the Wired Network via Web User Interface

The followings take configurations of a SIP-T46G IP phone running firmware version 81 as examples.

To configure VLAN for Internet (WAN) port via web user interface:

1. Log into the web user interface with the administrator credential.
The default administrator user name and password are both "admin".
2. Click on **Network->Advanced**.

3. In the **VLAN** block, select the desired value from the pull-down list of **WAN Port Active**.
4. Enter the VLAN ID in the **VID (1-4094)** field.
5. Select the desired value (0-7) from the pull-down list of **Priority**.
7 is the highest priority.



6. Click **Confirm** to accept the change.
The web user interface prompts the warning "Some settings you changed take effect when you restart your machine! Do you want to reboot now?".
7. Click **OK** to reboot the IP phone.

To configure VLAN for PC port via web user interface:

1. Log into the web user interface with the administrator credential.
The default administrator user name and password are both "admin".
2. Click on **Network->Advanced**.
3. In the **VLAN** block, select the desired value from the pull-down list of **PC Port Active**.
4. Enter the VLAN ID in the **VID (1-4094)** field.
5. Select the desired value (0-7) from the pull-down list of **Priority**.

7 is the highest priority.



6. Click **Confirm** to accept the change.

The web user interface prompts the warning “Some settings you changed take effect when you restart your machine! Do you want to reboot now?”.

7. Click **OK** to reboot the IP phone.

To configure VLAN for Internet (WAN) port via phone user interface:

1. Press **Menu->Advanced** (password: admin) ->**Network->VLAN->WAN Port**.
2. Press ◀ or ▶, or the **Switch** soft key to select the desired value from **VLAN Status** field.
3. Enter the VLAN ID (1-4094) in the **VID Number** field.
4. Enter the desired value (0 to 7) in the **Priority** field.

7 is the highest priority.



5. Press the **Save** soft key to accept the change.

The IP phone reboots automatically to make settings effective after a period of time.

To configure VLAN for PC port via phone user interface:

1. Press **Menu->Advanced** (password: admin) ->**Network->VLAN->PC Port**.
2. Press ◀ or ▶, or the **Switch** soft key to select the desired value from **VLAN Status**

field.

3. Enter the VLAN ID (1-4094) in the **VID Number** field.
4. Enter the desired value (0 to 7) in the **Priority** field.
7 is the highest priority.



5. Press the **Save** soft key to accept the change.

The IP phone reboots automatically to make settings effective after a period of time.

Configuring VLAN Feature in the Wired Network Using Configuration Files

The following IP phones use the new auto provisioning mechanism:

- SIP-T58V/T58A/T56A/CP960 IP phones running firmware version 80 or later
- SIP-T54S/T52S/T48G/T48S/T46G/T46S/T42G/T42S/T41P/T41S/T40P/T40G/T29G/T27P/T27G/T23P/T23G/T21(P) E2/T19(P) E2 IP, CP860, CP920, W60, W52P and W56P phones running firmware version 81 or later

Other IP phones or the IP phones listed above running old firmware version use the old auto provisioning mechanism.

For Old Auto Provisioning Mechanism

To configure VLAN for Internet (WAN) port and PC port using configuration file:

1. Add/Edit VLAN for Internet (WAN) port and PC port parameters in the configuration file (e.g., y000000000028.cfg).

The following table shows the information of parameters:

Parameters	Permitted Values	Default
network.vlan.internet_port_enable	0 or 1	0
<p>Description: Enables or disables the IP phone to tag VLAN ID in packets sent from the Internet (WAN) port.</p>		

Parameters	Permitted Values	Default
0 -Disabled 1 -Enabled		
network.vlan.internet_port_vid	Integer from 1 to 4094	1
Description: Configures the VLAN ID that associates with the particular VLAN.		
network.vlan.internet_port_priority	Integer from 0 to 7	0
Description: Specifies the priority used for transmitting VLAN packets.		
network.vlan.pc_port_enable	0 or 1	0
Description: Enables or disables the IP phone to tag VLAN ID in packets sent from the PC port. 0 -Disabled 1 -Enabled		
network.vlan.pc_port_vid	Integer from 1 to 4094	1
Description: Configures the VLAN ID that associates with the particular VLAN.		
network.vlan.pc_port_priority	Integer from 0 to 7	0
Description: Specifies the priority used for transmitting VLAN packets.		

The following shows an example of VLAN configuration in configuration files:

```

network.vlan.internet_port_enable = 1
network.vlan.internet_port_vid = 77
network.vlan.internet_port_priority = 5
network.vlan.pc_port_enable = 1
network.vlan.pc_port_vid = 76
network.vlan.pc_port_priority = 3
    
```

2. Upload configuration files to the root directory of the provisioning server and trigger IP phones to perform an auto provisioning for configuration update.

For more information on auto provisioning, refer to [Yealink_SIP-T2 Series_T19\(P\)](#)

*E2_T4_Series_CP860_W56P_IP_Phones_Auto_Provisioning_Guide.***For New Auto Provisioning Mechanism**

To configure VLAN for Internet (WAN) port and PC port using configuration file:

1. Add/Edit VLAN for Internet (WAN) port and PC port parameters in the configuration file (e.g., static.cfg).

The following table shows the information of parameters:

Parameters	Permitted Values	Default
static.network.vlan.internet_port_enable	0 or 1	0
Description: Enables or disables the IP phone to tag VLAN ID in packets sent from the Internet (WAN) port. 0 -Disabled 1 -Enabled		
static.network.vlan.internet_port_vid	Integer from 1 to 4094	1
Description: Configures the VLAN ID that associates with the particular VLAN.		
static.network.vlan.internet_port_priority	Integer from 0 to 7	0
Description: Specifies the priority used for transmitting VLAN packets.		
static.network.vlan.pc_port_enable	0 or 1	0
Description: Enables or disables the IP phone to tag VLAN ID in packets sent from the PC port. 0 -Disabled 1 -Enabled		
static.network.vlan.pc_port_vid	Integer from 1 to 4094	1
Description: Configures the VLAN ID that associates with the particular VLAN.		
static.network.vlan.pc_port_priority	Integer from 0 to 7	0

Parameters	Permitted Values	Default
<p>Description: Specifies the priority used for transmitting VLAN packets.</p>		

The following shows an example of VLAN configuration in configuration files:

```
static.network.vlan.internet_port_enable = 1
static.network.vlan.internet_port_vid = 77
static.network.vlan.internet_port_priority = 5
static.network.vlan.pc_port_enable = 1
static.network.vlan.pc_port_vid = 76
static.network.vlan.pc_port_priority = 3
```

- Reference the configuration file in the boot file (e.g., y000000000000.boot).

Example:

```
include:config "http://10.2.1.158/static.cfg"
```

- Upload the boot file and configuration file to the root directory of the provisioning server.
- Trigger IP phones to perform an auto provisioning for configuration update.

For more information on auto provisioning, refer to [Yealink SIP IP Phones Auto Provisioning Guide_V81](#).

Configuring VLAN Feature in the Wireless Network

You can enable or disable VLAN, and set specific VLAN IDs and priorities for the wireless network. It is only applicable to SIP VP-T49G IP phones. VLAN feature in the wireless network can be configured using the configuration files only.

To configure VLAN feature in the wireless network using configuration file:

- Add/Edit VLAN for wireless network parameters in the configuration file (e.g., y0000000000051.cfg).

The following table shows the information of parameters:

Parameters	Permitted Values	Default
wifi.vlan_enable	0 or 1	0
<p>Description: Enables or disables VLAN discovery feature in the wireless network for the IP phone.</p> <p>0-Disabled 1-Enabled</p>		

Parameters	Permitted Values	Default
network.vlan.wifi_enable	0 or 1	0
Description: Enables or disables manual configuration of VLAN feature in the wireless network for the IP phone. 0 -Disabled 1 -Enabled		
network.vlan.wifi_vid	Integer from 1 to 4094	1
Description: Configures VLAN ID in the wireless network for the IP phone.		
network.vlan.wifi_priority	Integer from 0 to 7	0
Description: Configures VLAN priority in the wireless network for the IP phone.		

The following shows an example of VLAN configuration in configuration files:

```
wifi.vlan_enable = 1
network.vlan.wifi_enable = 1
network.vlan.wifi_vid = 77
network.vlan.wifi_priority = 3
```

2. Upload configuration files to the root directory of the provisioning server and trigger IP phones to perform an auto provisioning for configuration update.

For more information on auto provisioning, refer to [Yealink SIP-T2 Series T19\(P\) E2_T4_Series_CP860_W56P_IP_Phones_Auto_Provisioning_Guide](#).

Verifying the Configuration

The IP phone reboots after VLAN feature has been enabled. After starting up, the IP phone will be assigned with a subnet address defined for VLAN 77.

The following figure shows the VLAN ID sent and received by the IP phone:

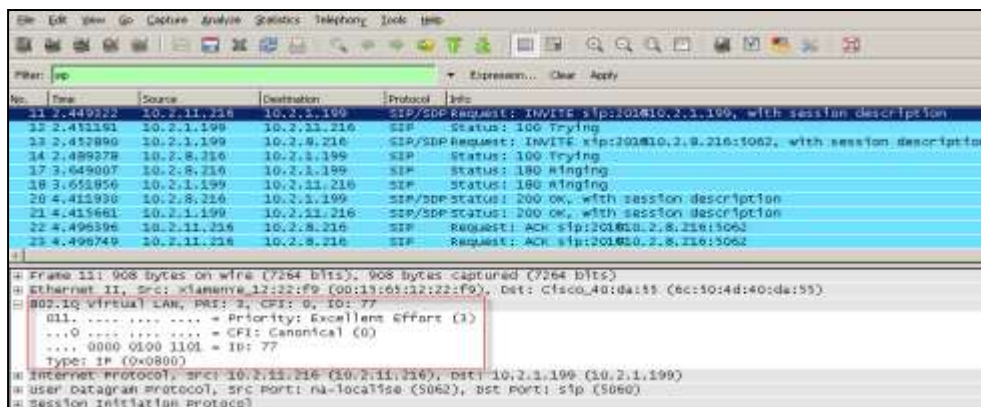

Appendix

Appendix A: Glossary

IEEE (Institute of Electrical and Electronics Engineers) –a professional association headquartered in New York City that is dedicated to advancing technological innovation and excellence.

TIA (Telecommunications Industry Association) –accredited by the American National Standards Institute (ANSI) to develop voluntary, consensus-based industry standards for a wide variety of ICT products.

IEEE 802.3 –a working group and a collection of IEEE standards produced by the working group defining the physical layer and data link layer's media access control (MAC) of wired Ethernet.

Port-based VLAN –a port-based VLAN is a group of ports on a Gigabit Ethernet Switch that form a logical Ethernet segment. Each port of a port-based VLAN can belong to only one VLAN at a time.

Port and Protocol-based VLAN –initially defined in IEEE 802.1v (currently amended as part of 802.1Q-2003) enables data frame classification and assignment to unique VLANs based on the received data frame type and the protocol information in its payload.

TPID (tag protocol identifier) –a 16-bit field set to a value of 0x8100 in order to identify the frame as an IEEE 802.1Q-tagged frame. It is used to distinguish the frame from untagged frames.

PCP (Priority Code Point) –a 3-bit field which refers to the IEEE 802.1p priority. It indicates the frame priority level. Values are from 0 (best effort) to 7 (highest); 1 represents the lowest priority.

CFI (Canonical Format Indicator) –used for compatibility reason between Ethernet type network and Token Ring type network. It is always set to zero for Ethernet switches. If a frame received at an Ethernet port has a CFI set to 1, then that frame should not be forwarded as it is to an untagged port.

Appendix B: System Names

The following table outlines the Yealink phone models and their system names:

Model	System Name
CP860	CP860
CP920	SIP-CP920
CP960	SIP-CP960
W52P/W56P	W52P
W60	SIP-W60B
SIP-T58V/A	SIP-T58
SIP-T56A	SIP-T56A
SIP VP-T49G	SIP VP-T49G
SIP-T54S	SIP-T54S
SIP-T52S	SIP-T52S
SIP-T48G	SIP-T48G
SIP-T48S	SIP-T48S
SIP-T46G	SIP-T46G
SIP-T46S	SIP-T46S
SIP-T42G	SIP-T42G
SIP-T42S	SIP-T42S
SIP-T41P	SIP-T41P
SIP-T41S	SIP-T41S
SIP-T40P	SIP-T40P
SIP-T40G	SIP-T40G
SIP-T29G	SIP-T29G
SIP-T27P	SIP-T27P
SIP-T27G	SIP-T27G
SIP-T23P	SIP-T23P
SIP-T23G	SIP-T23G
SIP-T21(P) E2	SIP-T21P_ E2
SIP-T19(P) E2	SIP-T19P_ E2

Appendix C: Model Names

The following table outlines the Yealink phone models and their model names:

Model	Model Name
CP860	CP860
CP920	SCP920
CP960	SIP-CP960
W52P/W56P	W52P
W60	W600
SIP-T58V/A	SIP-T58
SIP-T56A	SIP-T56A
SIP VP-T49G	T49
SIP-T54S	T54S
SIP-T52S	T52S
SIP-T48G	T48
SIP-T48S	T48S
SIP-T46G	T46
SIP-T46S	T46S
SIP-T42G	T42
SIP-T42S	T42S
SIP-T41P	T41
SIP-T41S	T41S
SIP-T40P	T40
SIP-T40G	T40G
SIP-T29G	T29
SIP-T27P/G	T27
SIP-T23P/G	T23
SIP-T21(P) E2	T21P_E2
SIP-T19(P) E2	T19P_E2

Appendix D: Power Values

The following table outlines the power value sent in LLDP-MED:

Model	Power Value
CP860	8100mW
CP920	7000mW
CP960	12000mW
W52P/W56P	1500mW
SIP-T58V/A	11400mW
SIP-T56A	8800mW
SIP-T54S	9500mW
SIP-T52S	9700mW
SIP-T48G	10600mW
SIP-T48S	10800mW
SIP-T46G	8000mW
SIP-T46S	7600mW
SIP-T42G	5900mW
SIP-T42S	6800mW
SIP-T41P	3200mW
SIP-T41S	12500mW
SIP-T40P	5300mW
SIP-T40G	6000mW
SIP-T29G	8100mW
SIP-T27P	6000mW
SIP-T27G	7100mW
SIP-T23P	6500mW
SIP-T23G	8200mW
SIP-T21P E2	6500mW
SIP-T19P E2	5000mW

Appendix E: Normative References

LLDP and LLDP-MED: http://en.wikipedia.org/wiki/Link_Layer_Discovery_Protocol

CDP: http://en.wikipedia.org/wiki/Cisco_Discovery_Protocol

IEEE 802.3: <http://www.ieee802.org/3/>

VLAN: http://en.wikipedia.org/wiki/Virtual_LAN

IEEE 802.1q: <http://en.wikipedia.org/wiki/802.1Q>

LLDP on Cisco Switch:

http://www.cisco.com/en/US/docs/switches/lan/catalyst3750/software/release/12.2_55_se/configuration/guide/swlldp.html

CDP on Cisco Switch:

http://www.cisco.com/c/en/us/td/docs/switches/lan/catalyst3750/software/release/12-2_55_se/configuration/guide/scg3750/swcdp.html

Customer Feedback

We are striving to improve our documentation quality and we appreciate your feedback. Email your opinions and comments to DocsFeedback@yealink.com.